

# KÄRCHER

## WV 5 Plus N

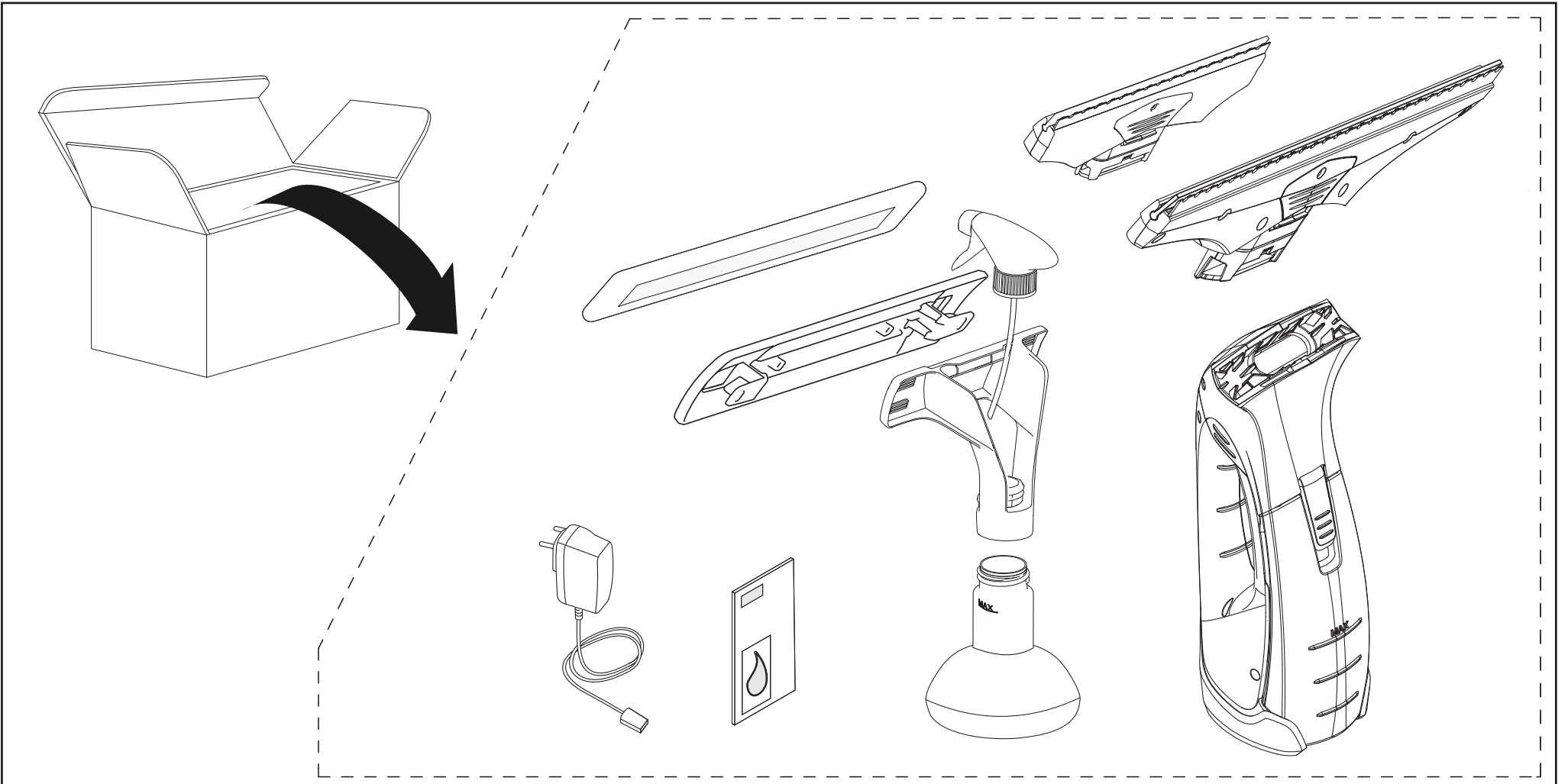

	3,7 V		IPX4		0,7 kg
	10 W		100 ml		185 min
	5,5 V 600 mA		50 db(A)		35 min

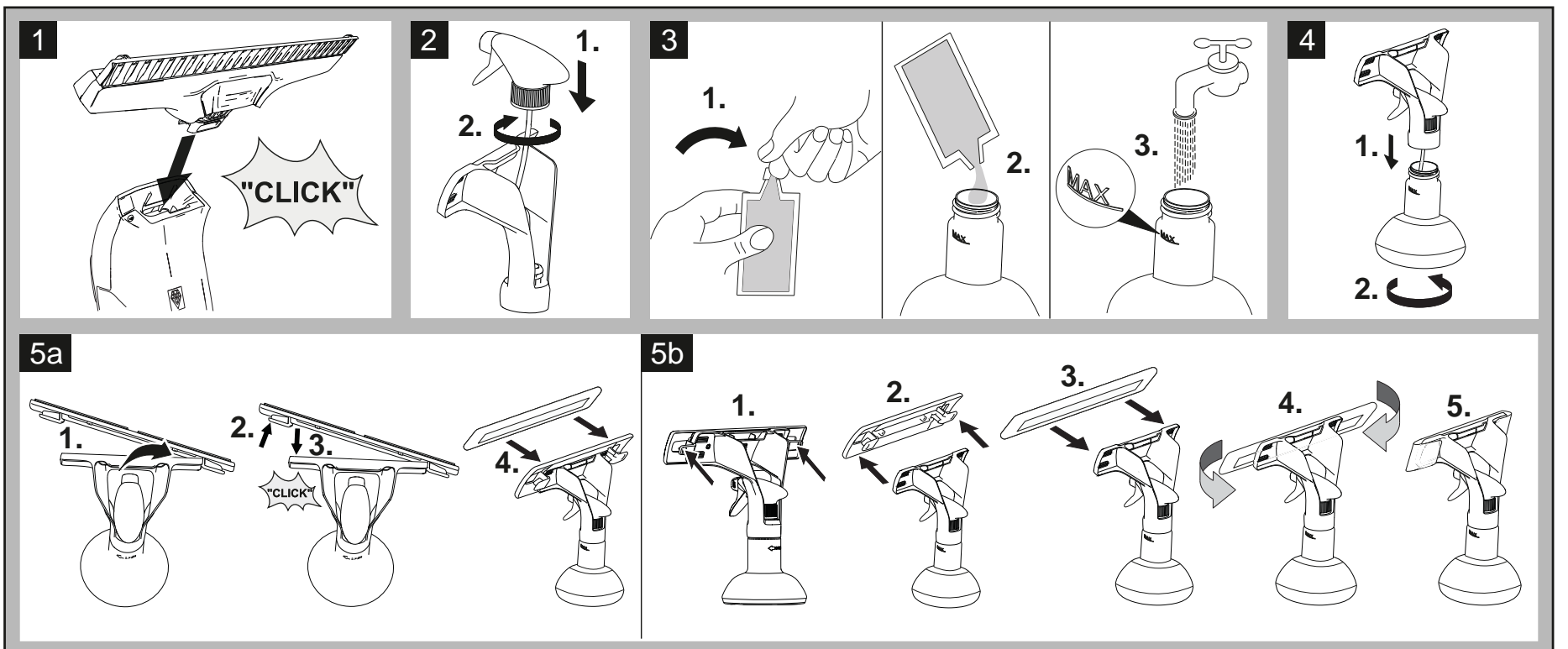
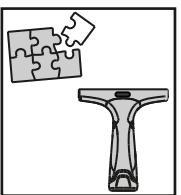

EAC

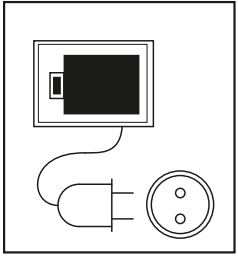

**1**

**2**

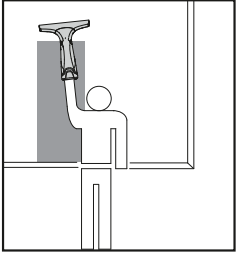

**1**

**2**

**3**

**4.1**

**4.2**

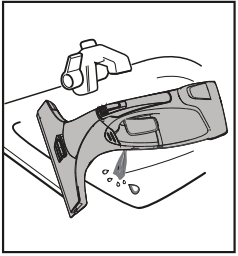

**1**

**2**

**3**

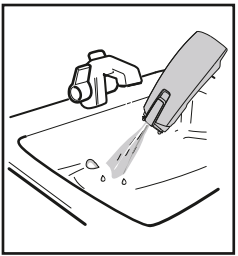

**1**

**2**

**3**

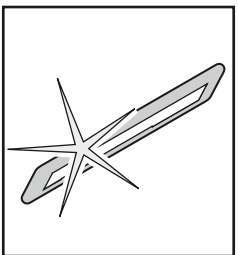

**1**

**2**

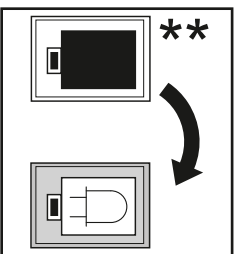

**1**

**2**

