

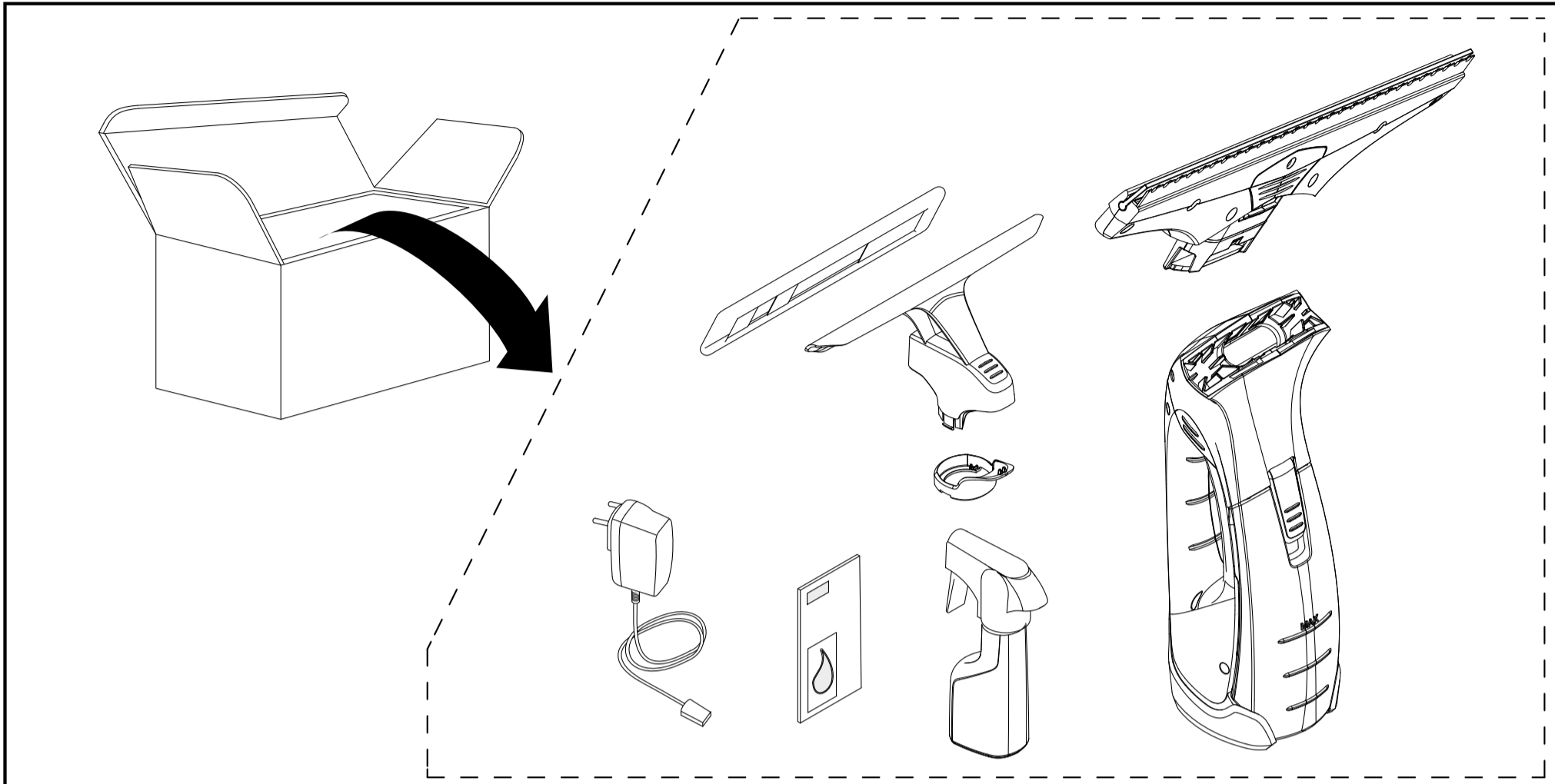

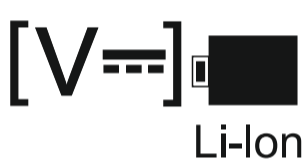

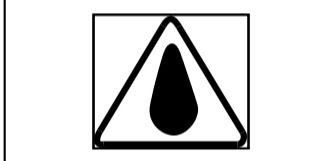

## WV 2 Plus

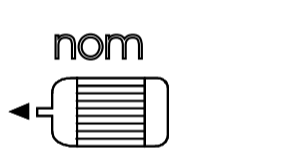
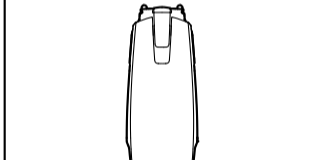

 Li-Ion	3,7 V		IP X4		0,6 kg
 nom	10 W		100 ml		120 min
	V 5,5 mA 600		50 db(A)		25 min

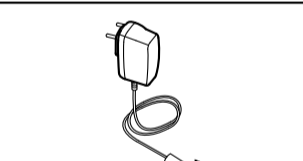
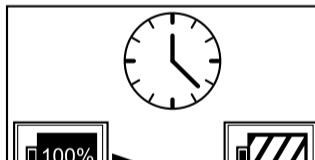