

8 7 6 5 4 3 2 1

REVISION						
REV	DESCRIPTION	ECR	REV BY	APPR BY	AGENCY APPR	DATE
A	RELEASE FOR PRODUCTION (REV 1)					
B	ADDED PEDAL PLATFORM (PG 1), UPDATED BOM TO INCLUDE ONLY HARNESSES PART NUMBERS 86313700, 86239120, 86313710. REMOVED "W/RING CABLES" FROM GROUP NAME.	0907150820	DMH	ELS		7-22-09

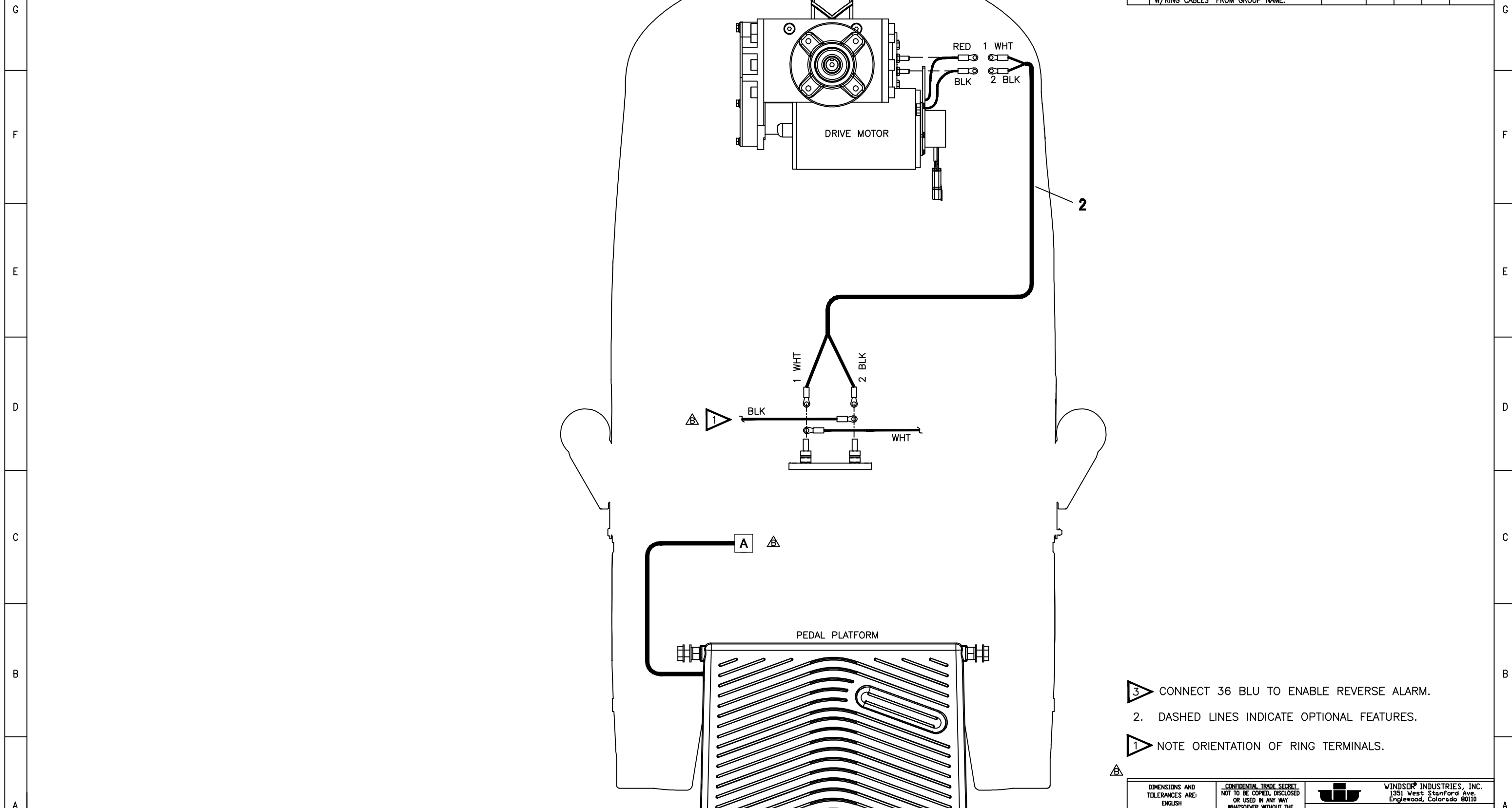

- 3 CONNECT 36 BLU TO ENABLE REVERSE ALARM.
- 2. DASHED LINES INDICATE OPTIONAL FEATURES.
- 1 NOTE ORIENTATION OF RING TERMINALS.

REF	PART NO	DESCRIPTION	QTY
3	86313700	HARNESS, PANEL 2 STAGE	1
2	86239120	HARNESS, CHARIOT PROPEL	1
1	86313710	HARNESS, MAIN	1

DIMENSIONS AND TOLERANCES ARE: INCH .X ± .1 .XX ± .03 .XXX ± .010 < ± 1"	CONFIDENTIAL TRADE SECRET NOT TO BE COPIED, DISCLOSED OR USED IN ANY WAY WHATSOEVER WITHOUT THE WRITTEN PERMISSION OF WINDSOR INDUSTRIES, INC. DWG BY: SG DATE: 02-10-2009	WINDSOR INDUSTRIES, INC. 1351 West Stanford Ave. Englewood, Colorado 80110	
		GRP WIRING, DISK	
ISSUED ON: 2-26-2009 BY: ELS	CHECKED BY: RCC APPROVED BY: AF	SIZE: D SCALE: .750 DWG NO: 86320230	REV: B DO NOT SCALE DRAWING SHEET: 1 OF 6

8 7 6 5 4 3 2 1

REVISION						
REV	DESCRIPTION	ECR	REV BY	APPR BY	AGENCY APPR	DATE
-	SEE SHEET 1					

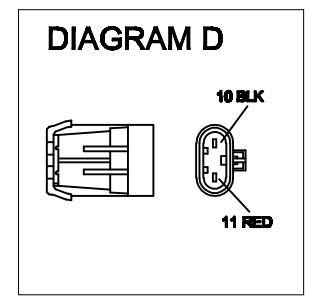
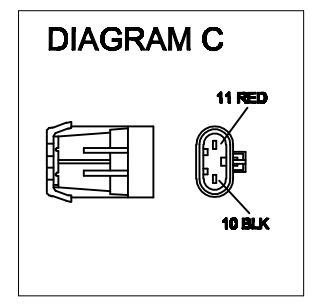
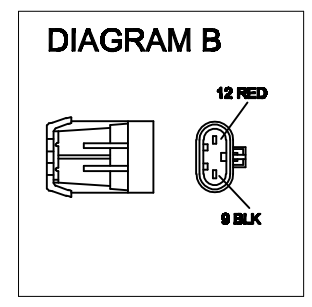
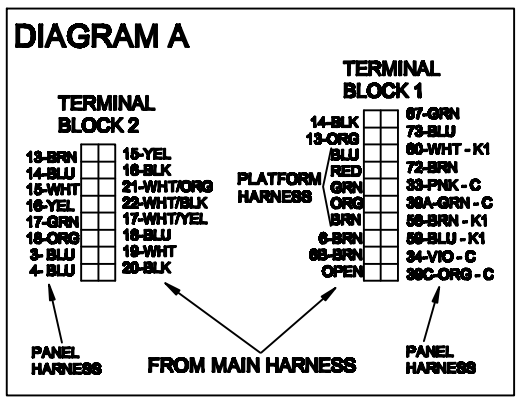
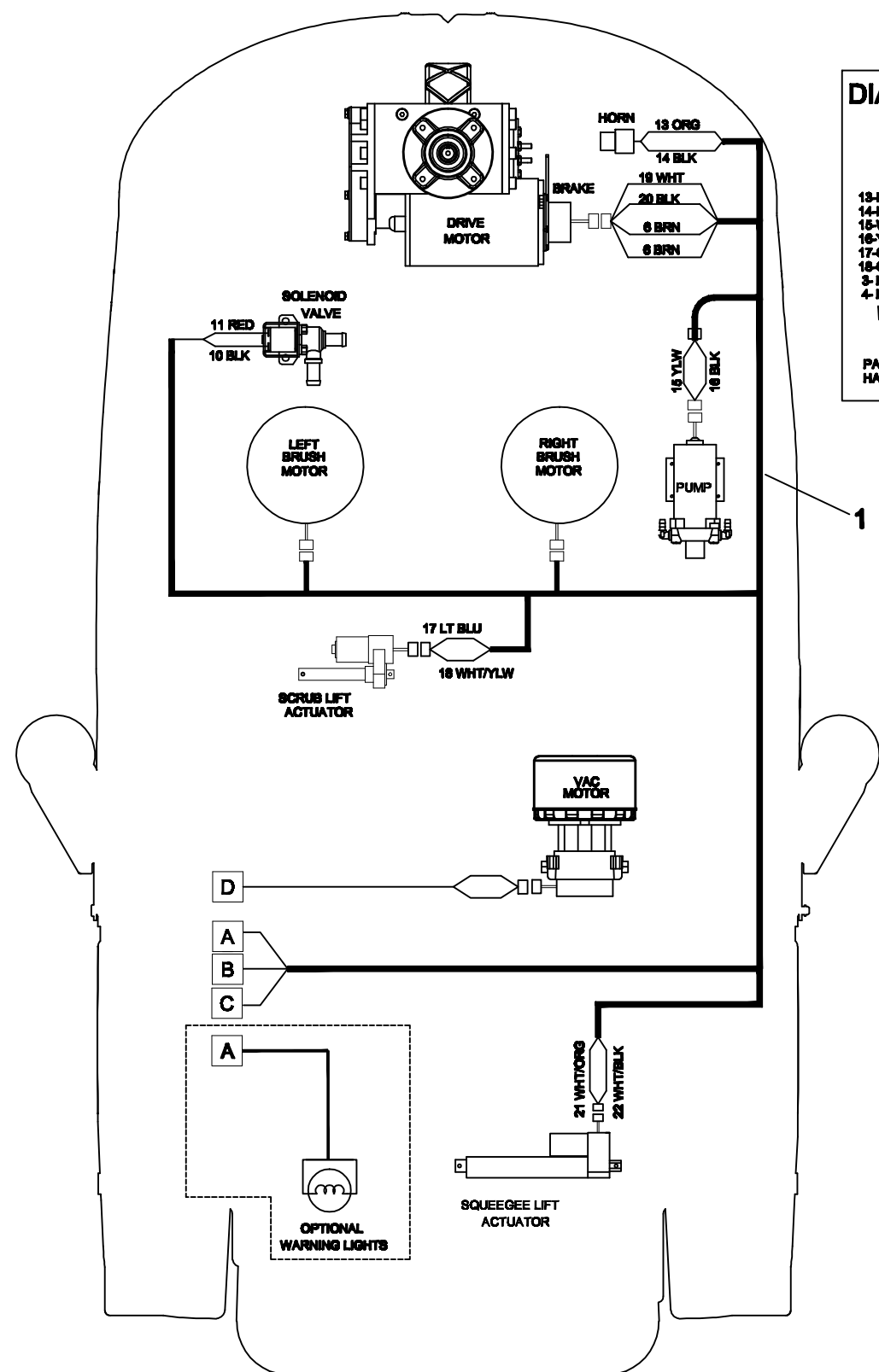

DIMENSIONS AND TOLERANCES ARE: ENGLISH INCH .X ± .1 .XX ± .03 .XXX ± .010 < ± 1"	CONFIDENTIAL TRADE SECRET NOT TO BE COPIED, DISCLOSED OR USED IN ANY WAY WHATSOEVER WITHOUT THE WRITTEN PERMISSION OF WINDSOR INDUSTRIES, INC.	WINDSOR INDUSTRIES, INC. 1351 West Stanford Ave. Englewood, Colorado 80110	
		GRP WIRING, DISK	
DATE: 6-1-2009	DRAWING NO: 86320230	SIZE: D	SCALE: .750
ISSUED ON:	CHECKED BY:	DD NOT SCALE DRAWING	SHEET: 2 OF 6

REVISION					
REV	DESCRIPTION	ECR	BY	DATE	
1	SEE SHEET 1				

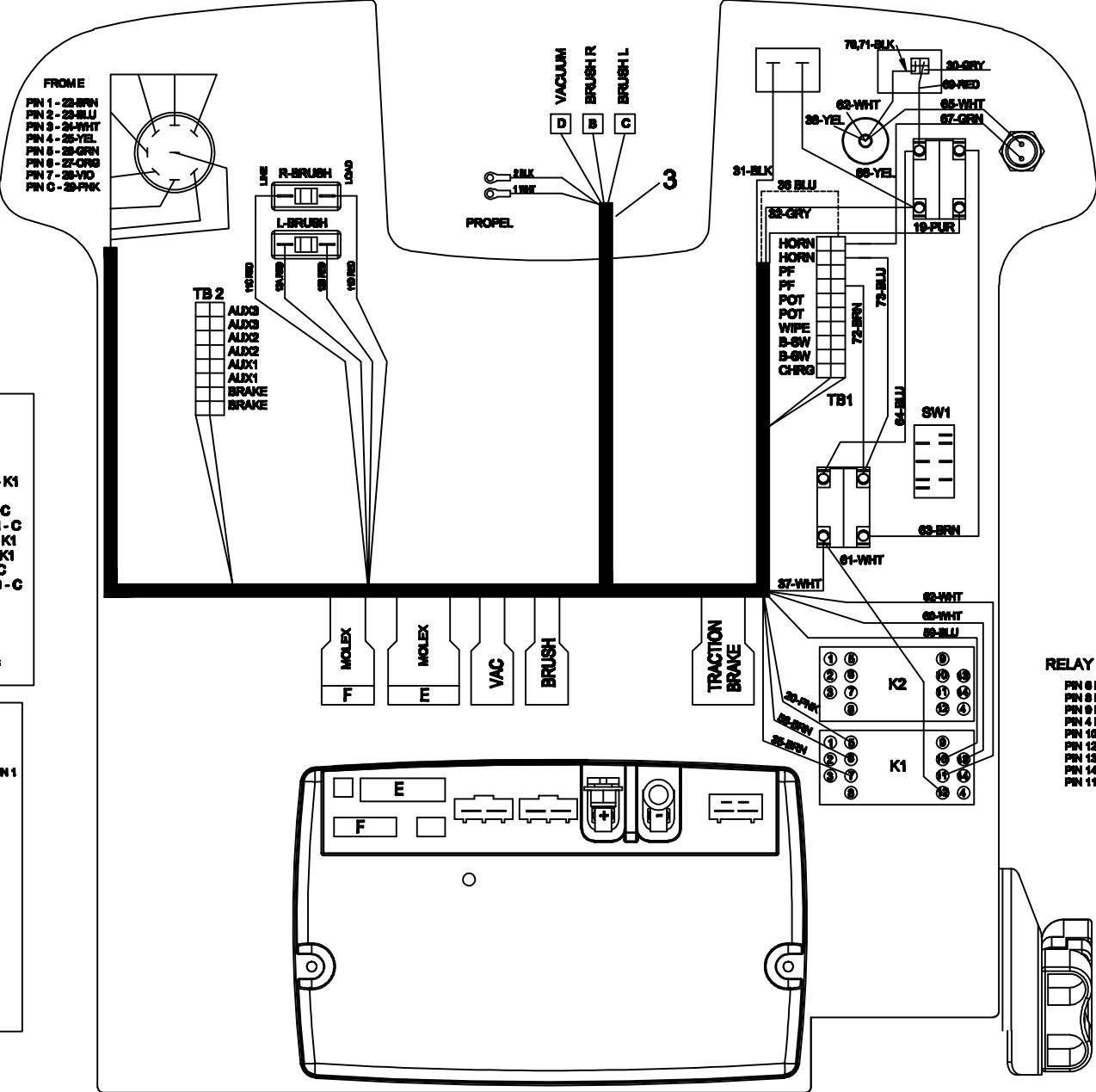
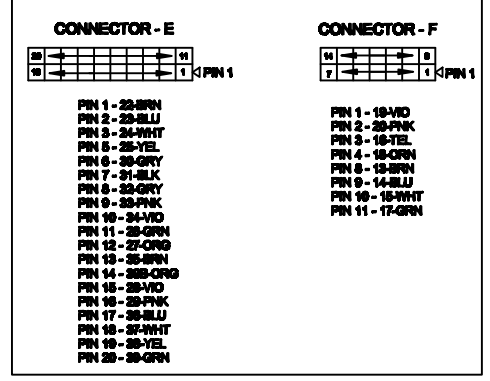
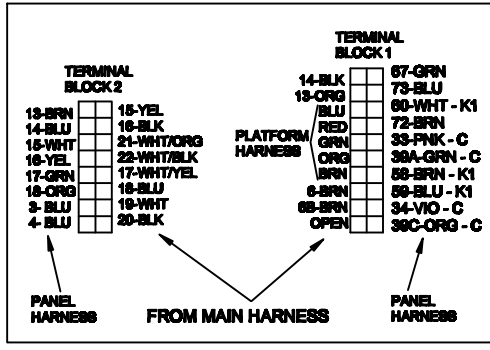
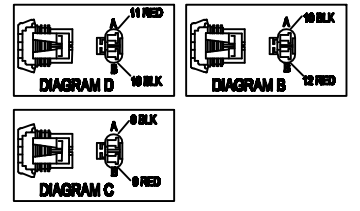
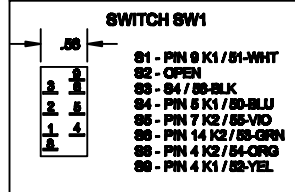

DIMENSIONS AND TOLERANCES ARE: INCH X.X .1 X.XX .05 X.XXX .01 < 4"	CONFIDENTIAL TRADE SECRET NOT TO BE COPIED, REPRODUCED OR USED IN ANY WAY WITHOUT PERMISSION OF WINDSOR INDUSTRIES, INC.	WINDSOR INDUSTRIES, INC. 1351 West Stanford Ave. Englewood, Colorado 80110	
		GRP WIRING, DISK	
ISSUED BY: [Signature] DATE: 6-1-2009	CHECKED BY: DMH DATE: 6-1-2009	SIZE: D SCALE: .750 DRAWING: DO NOT SCALE DRAWING	DWG NO: 86320230 REV: B SHEET: 3 OF 6

REVISION						
REV	DESCRIPTION	ECR	REV BY	APPR BY	AGENCY APPR	DATE
-	SEE SHEET 1					

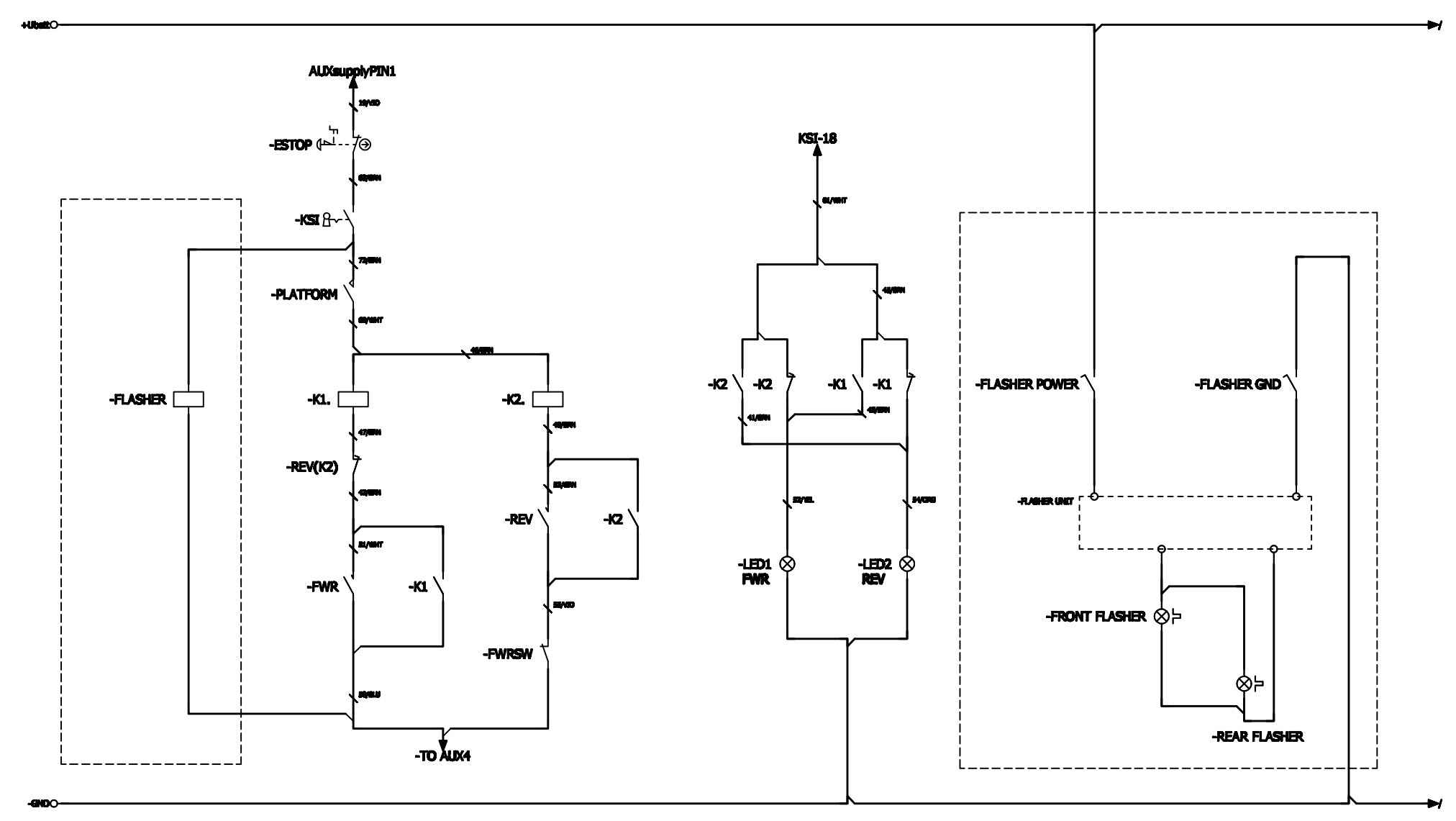

NOTE: ANY REVISIONS MADE TO THIS PAGE MUST ALSO BE DONE IN EPLAN FILE 86320230.

DIMENSIONS AND TOLERANCES ARE: ENGLISH INCH X ± .1 .XX ± .03 .XXX ± .010 ∠ ± 1°	CONFIDENTIAL TRADE SECRET NOT TO BE COPIED, DISCLOSED OR USED IN ANY WAY WHATSOEVER WITHOUT THE WRITTEN PERMISSION OF WINDSOR INDUSTRIES, INC. DWG BY: DMH	WINDSOR INDUSTRIES, INC. 1351 West Stanford Ave. Englewood, Colorado 80110	
		GRP WIRING, DISK	
DATE: 6-1-2009	SIZE: D	SCALE: .750	DWG NO: 86320230
ISSUED ON: _____ BY: _____	CHECKED BY: _____ APPROVED BY: _____	DO NOT SCALE DRAWING	SHEET: 4 OF 6

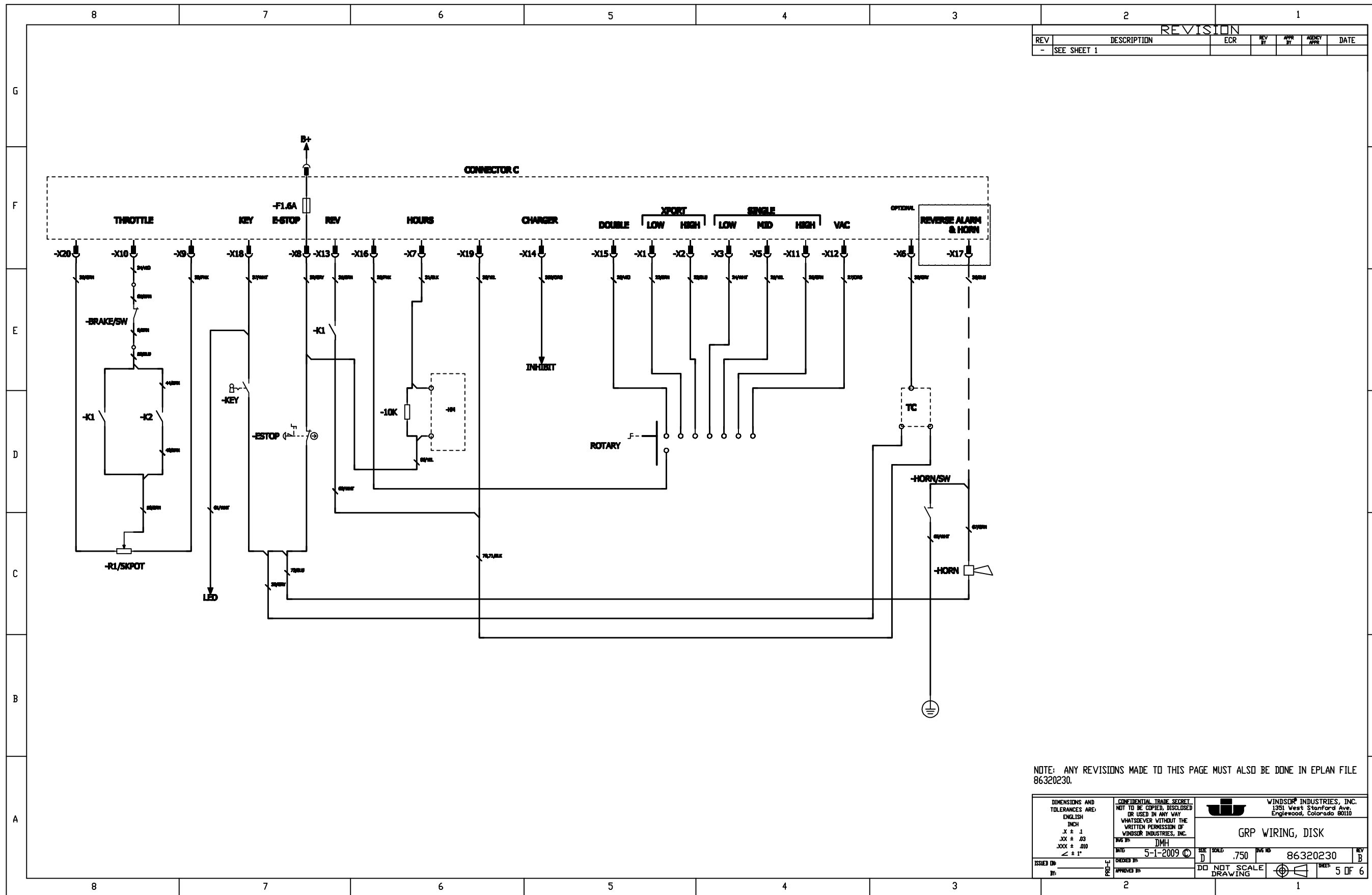

REVISION						
REV	DESCRIPTION	ECR	REV BY	APP BY	AGENCY	DATE
-	SEE SHEET 1					

NOTE: ANY REVISIONS MADE TO THIS PAGE MUST ALSO BE DONE IN EPLAN FILE 86320230.

DIMENSIONS AND TOLERANCES ARE: ENGLISH INCH .X ± .1 .XX ± .03 .XXX ± .010 $\angle \pm 1^\circ$	CONFIDENTIAL TRADE SECRET NOT TO BE COPIED, DISCLOSED OR USED IN ANY WAY WHATSOEVER WITHOUT THE WRITTEN PERMISSION OF WINDSOR INDUSTRIES, INC. DWG NO: DMH DATE: 5-1-2009	WINDSOR INDUSTRIES, INC. 1351 West Stanford Ave. Englewood, Colorado 80110	
		GRP WIRING, DISK	
ISSUED BY: [Signature] DATE:	CHECKED BY: [Signature] DATE:	SIZE: D SCALE: .750	PART NO: 86320230 SHEET: 5 OF 6

REVISION						
REV	DESCRIPTION	ECR	REV BY	APPR BY	AGENCY APPR	DATE
-	SEE SHEET 1					

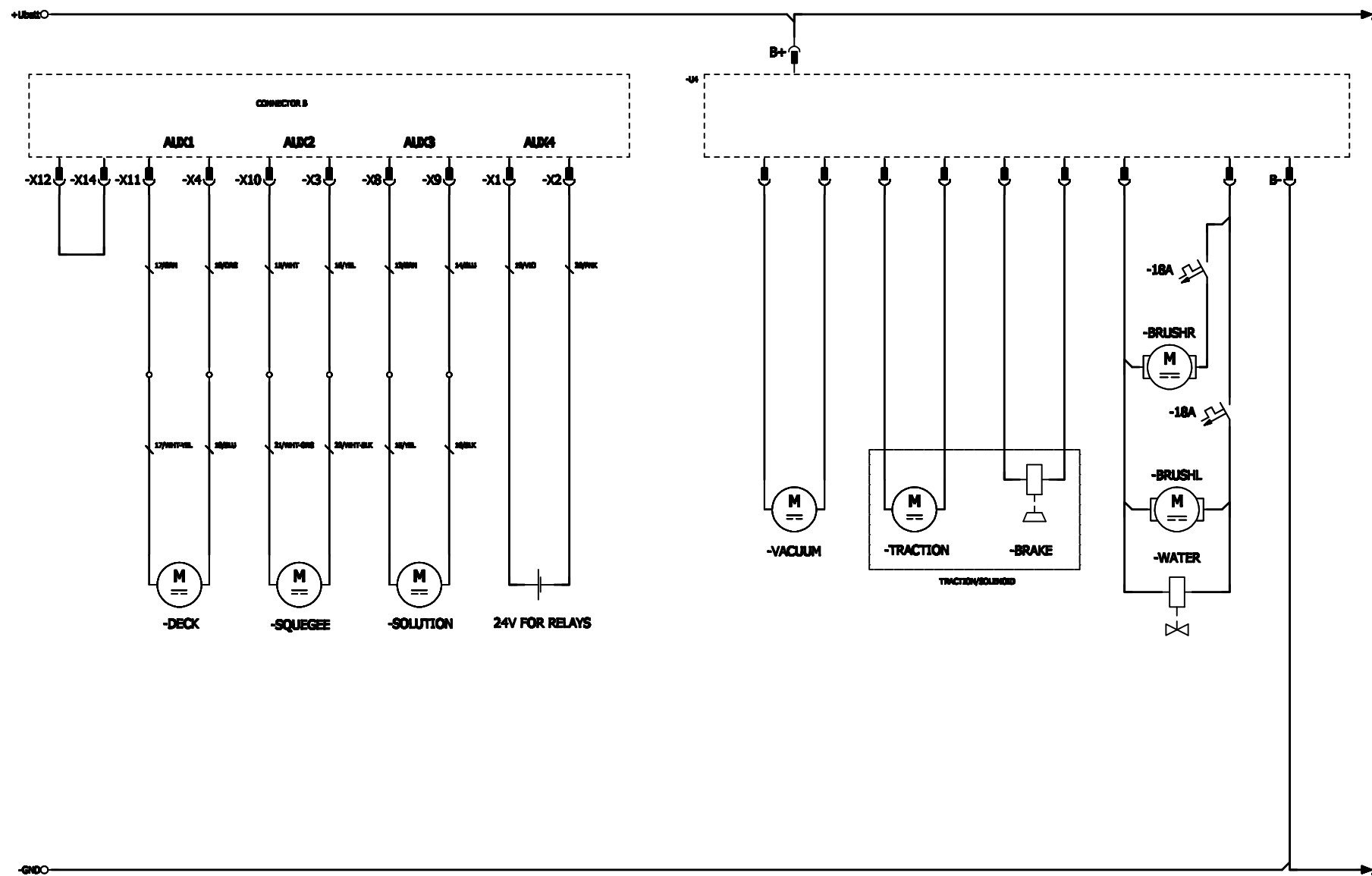

NOTE: ANY REVISIONS MADE TO THIS PAGE MUST ALSO BE DONE IN EPLAN FILE 86320230.

DIMENSIONS AND TOLERANCES ARE: ENGLISH INCH X ± .1 .XX ± .03 .XXX ± .010 < ± .1"	CONFIDENTIAL TRADE SECRET NOT TO BE COPIED, DISCLOSED OR USED IN ANY WAY WHATSOEVER WITHOUT THE WRITTEN PERMISSION OF WINDSOR INDUSTRIES, INC. DATE: 6-1-2009 ©	WINDSOR INDUSTRIES, INC. 1351 West Stanford Ave. Englewood, Colorado 80110	
		GRP WIRING, DISK	
ISSUED ON: _____ BY: _____	CHECKED BY: _____ APPROVED BY: _____	SIZE: D SCALE: .750 DRAWING: DD NOT SCALE DRAWING	PROJ NO: 86320230 SHEET: 6 OF 6